

Instruction Manual

HI 9828 Multiparameter



Hanna Instruments reserves the right to modify the design, construction and appearance of its products without advance notice.

Dear Customer,

Thank you for choosing a Hanna Instruments product.

Please read this instruction manual carefully before using the instrument. It will provide you with the necessary information for correct use of the instrument, as well as a precise idea of its versatility.

If you need additional technical information, do not hesitate to e-mail us at tech@hannainst.com or see the back cover for our worldwide contact list.

This instrument is in compliance with the CE directives.

TABLE OF CONTENTS

CHAPTER 1- INTRODUCTION

1.1 Preliminary examination	8
1.2 Model identification	8
1.3 General description	9
1.4 Power supply	10
1.4.1 Batteries installation	10
1.4.2 Recharging batteries	10
1.5 Probe description & installation	11
1.5.1 D.O. sensor activation	11
1.5.2 Installation	12
1.5.3 pH & pH/ORP sensors	13
1.6 Specifications	14
1.7 Display & keyboard description	18
1.8 Help function	19

CHAPTER 2 - MEASUREMENT MODE

2.1 Procedure	20
---------------------	----

CHAPTER 3 - SYSTEM SETUP

3.1 Measurement setup	21
3.2 System setup	23
3.3 Table of measurement & setup items	27

CHAPTER 4 - CALIBRATION MODE

4.1 Quick calibration	29
4.2 pH calibration	31
4.2.1 Preparation	31
4.2.2 Procedure	32
4.2.3 Error list	33
4.3 Dissolved oxygen calibration	34
4.3.1 Procedure	34

4.4 Conductivity calibration	36
4.4.1 Procedure	36
4.5 Atmospheric pressure	38
4.5.1 Procedure	38
4.6 ORP calibration	38
4.6.1 Procedure	38
4.7 Temperature calibration	39
4.7.1 Procedure	39
CHAPTER 5 - LOGGING MODE	
5.1 Logging	40
5.1.1 Logging options	40
5.2 Log data setup	41
5.2.1 Lots	41
5.2.2 Delete all lots	43
5.2.3 Remarks	43
5.2.4 Delete all remarks	44
5.2.5 Tags	44
CHAPTER 6 - GLP	
6.1 Probe information	46
6.2 pH	47
6.3 Dissolved oxygen	47
6.4 Conductivity	48
6.5 Atmospheric pressure	48
6.6 ORP	49
6.7 Temperature	49
CHAPTER 7 - PC CONNECTION	
7.1 Software installation	50
7.2 PC connection	50
CHAPTER 8 - MESSAGES & ERRORS	52

APPENDIX

A - PROBE MAINTENANCE 55
B - ACCESSORIES 57
C - WARRANTY 59

Chapter 1 - INTRODUCTION

1.1 PRELIMINARY EXAMINATION

Remove the instrument from the packing material and examine it carefully to make sure that no damage has occurred during shipping. If there is any noticeable damage, notify your Dealer or the nearest Hanna Customer Service Center immediately.

HI 9828 is supplied complete with:

- HI 769828DO DO/EC/Temperature probe
- HI 9828-27 quick calibration standard solution, 500 mL
- Probe maintenance kit
- 4 rechargeable C size, Ni-MH batteries
- Power adaptor & cable
- Cigarette lighter cable
- 5 i-Button[®] with holder
- HI 7698281 USB interface cable
- HI 92000 Windows[®] compatible software
- instruction manual
- rugged carrying case

NOTE: Save all packing materials until you are sure that the instrument functions correctly. Any damaged or defective items must be returned in their original packing materials together with the supplied accessories.

1.2 MODEL IDENTIFICATION

Based on probe cable length, there are 3 different models according to the following scheme.

HI 9828/x

X=4, 4 m probe cable
X=10, 10 m probe cable
X=20, 20 m probe cable

1.3 GENERAL DESCRIPTION

HI 9828 is a multiparameter system that benefits from years of experience of Hanna Instruments as a manufacturer of analytical instruments. Waterproof, resistant and easy to use, it is the ideal solution for field measurements of lakes and rivers. Thanks to the microprocessor based multisensor probe, it is possible to measure all the parameters necessary to evaluate the water quality, as Dissolved Oxygen saturation percentage, Conductivity, Specific Gravity and other parameters that ensure life in water as pH and temperature. It is also possible to use the same probe with different meters without the need to recalibrate the system.

Up to 12 parameters can be enabled and seen in the large graphic display with backlight. All the readings can be memorized and associated to a precise sampling area thanks to the i-Button system and the remarks that the operator can insert before or during measurements. The same data can be plotted on the meter and also downloaded to a PC by means of USB connector and HI92000 Windows® compatible application for successive elaborations.

The setting menu can be protected by password to avoid not authorized modifications and the help function is always available to explain the selected function, operation or message.

The main features of HI 9828 series include:

- Measurement of Dissolved Oxygen, pH, ORP, Conductivity and related parameters, Temperature, Atmospheric pressure and Seawater specific gravity;
- Field replaceable sensor modules for DO/Temperature/EC and pH/ORP;
- 5 interface languages: English, Italiano, Française, Espagnol, Portugues;
- Graphical display with backlight;
- GLP features;
- i-Button system to remark the sampling area;
- Up to 60,000 samples stored in 100 different lots;
- 4 C size Ni-MH rechargeable batteries;
- Possibility to recharge from mains power supply and from cigarette lighter;
- Password protection.

1.4 POWER SUPPLY

HI 9828 runs with 4 rechargeable C size, Ni-MH batteries.

On display the battery icon visualizes the remaining battery charge. When this icon starts blinking, it is necessary to recharge or to replace them with alkaline batteries. When the batteries completely rundown the meter automatically shuts off to avoid wrong readings.

1.4.1 Batteries installation

Battery replacement must only take place in a non-hazardous area.

Remove the 4 screws on the rear cover of the instrument and insert the batteries paying attention to the correct polarity.

IMPORTANT NOTE: To use alkaline C size batteries, it is necessary to move up the switch in the battery compartment.

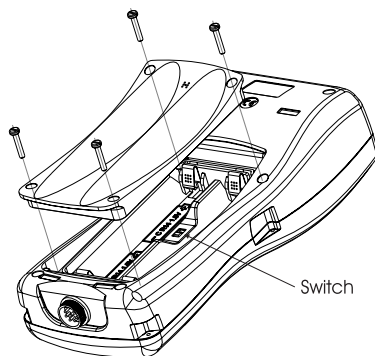

1.4.2 Recharging batteries

HI 9828 is supplied with two different cables for recharging batteries: HI 710045 and HI 710046.

Mains power supply

HI 710045 combined with the 12 Vdc adapter is used to recharge batteries from the mains power supply.

- With the meter OFF, disconnect the probe.
- Connect HI 710045 to the meter and to the power adapter; connect the adapter to the mains power supply.
- On display the message “Battery charging in progress” appears and then the battery icon.
- For complete batteries recharging 14 hours are necessary.

Battery charging in progress...

NOTE: It is possible to recharge batteries with the meter ON; if Auto shut-off feature is enabled, the meter will switch off automatically when the fixed time is expired.

Cigarette lighter supply

With HI 710046 it is possible to recharge HI 9828 with a car.

It is sufficient to connect the cable to the meter and to the Cigarette lighter of car.

- On display the message “Battery charging in progress” appears and then the battery icon.
- For complete batteries recharging 14 hours are necessary.

NOTE: It is possible to recharge batteries with the meter ON; if Auto shut-off feature is enabled, the meter will switch off automatically when the fixed time is expired.

1.5 PROBE DESCRIPTION & INSTALLATION

HI 9828 is supplied with HI 769828DO, probe for Dissolved Oxygen, Temperature and Conductivity measurements.

In the probe body it is also possible to insert a pH or pH/ORP sensor; please see Appendix A for the order codes.

The galvanic D.O. sensor with the built-in thermistor allow to have stable temperature compensated readings in few seconds. The thin permeable membrane isolates the sensor elements from the testing solution, but allows oxygen to enter. Oxygen that passes through the membrane causes a current flow, from which the oxygen concentration is determined.

Before installing the probe, it is necessary to activate the D.O. sensor; see paragraph 1.5.1 for procedure.

The conductivity sensor is a 4 rings system that allows stable and linear readings without interferences in all the range.

1.5.1 D.O. sensor activation

The D.O. probe is shipped dry. To hydrate the probe and prepare it for use proceed as follows:

- Remove the black & red plastic cap. This cap is used for shipping purposes only and can be thrown away.

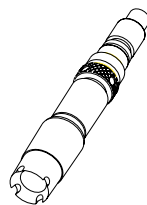

- Insert the supplied O-ring in the membrane.
- Rinse the supplied membrane with electrolyte while shaking it gently. Refill with clean electrolyte. Gently tap the membrane over a surface to ensure that no air bubbles remain trapped. To avoid damaging the membrane, do not touch it with your fingers.
- With the sensor facing down screw the cap clockwise to the end of the threads. Some electrolyte will overflow.

1.5.2 Installation

The multisensor probe can support 3 different electrodes, DO/Temperature, EC, pH/ORP. To make easier the installation, the 3 sensors have 3 different color codes: white for DO, orange for EC and yellow for pH/ORP

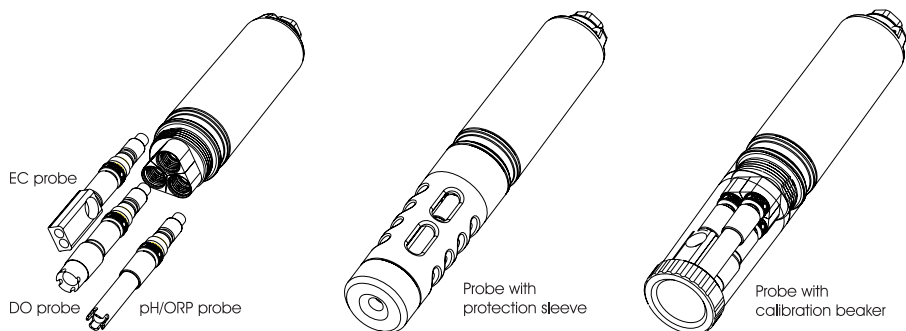

For the correct sensors installation, procede as follow:

- Insert the sensor with the right alignment to the corresponding coloured connector.
- Screw with the supplied tool the locking nut to fix the sensor.
- After sensors are mounted it is necessary to screw the protection sleeve for measurements or the transparent beaker for calibration.
- With the meter turned off, connect the probe to the DIN socket on the bottom of the meter by aligning the pins and pushing in the plug. Tighten the nut to ensure a good connection.

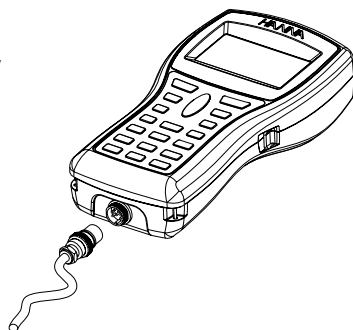

1.5.3 pH and pH/ORP sensors

As mentioned before HI 9828 is predisposed for pH and ORP measurements.

HI 769828PH and HI 769828PHO are probes with pH and pH/ORP sensors respectively. See the table below for electrodes specifications.

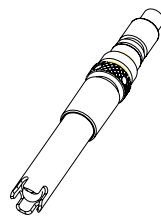

	Reference	Junction	Electrolyte	Tip	Body material
pH	double	cloth	gel	spheric	PEI
ORP	double	cloth	gel	Pt	PEI

To avoid clogging problems and ensure a fast response, the pH bulb must be kept moist at any time. Store the electrode with few drops of HI 70300L storage solution.

To make correct redox measurements the following conditions must prevail:

- The surface of the electrode must be cleaned and smooth.
- The surface of the electrode must undergo a pretreatment in order to respond quickly.

Because the Pt/PtO system depends on the pH, the pretreatment of the electrode may be determined by the pH and the redox potential values of the solution to be measured.

As a general rule, if the ORP mV reading corresponding to the pH value of the solution is higher than the values in the table below, an oxidizing pretreatment is necessary; otherwise a reducing pretreatment is necessary:

pH	mV	pH	mV	pH	mV	pH	mV	pH	mV	pH	mV
0	990	1	920	2	860	3	800	4	740	5	680
6	640	7	580	8	520	9	460	10	400	11	340
12	280	13	220	14	160						

For reducing pretreatment: immerse the electrode for a few minutes in HI 7091L.

For oxidizing pretreatment: immerse the electrode for a few minutes in HI 7092L.

1.6 SPECIFICATIONS

TEMPERATURE

Range	-5.00 to 55.00 °C; 23.00 to 131.00°F; 268.15 to 328.15 K
Resolution	0.01 °C; 0.01 °F; 0.01 K
Accuracy	± 0.15 °C; ± 0.27 °F; ±0.15 K
Calibration	automatic at 1 custom point

pH

Range	0.00 to 14.00 pH; ± 600.0 mV
Resolution	0.01 pH; 0.1 mV
Accuracy	± 0.02 pH ± 0.5 mV
Calibration	automatic 1, 2 or 3 points with 5 memorized standard buffers (pH 4.01, 6.86, 7.01, 9.18, 10.01) or 1 custom buffer

ORP

Range	± 2000.0 mV
Resolution	0.1 mV
Accuracy	± 1.0 mV
Calibration	automatic at 1 custom point

DISSOLVED OXYGEN

Range	0.0 to 500.0 % 0.00 to 50.00 mg/L
Resolution	0.1 % 0.01 mg/L
Accuracy	0.0 to 300.0 %: ± 1.5 % of reading or ± 1.0% whichever is greater; 300.0 to 500.0 %: ± 3% of reading 0.00 to 30.00 mg/L: ± 1.5 % of reading or 0.10 mg/L whichever is greater; 30.00 mg/L to 50.00 mg/L: ± 3% of reading
Calibration	automatic 1 or 2 points at 0, 100 % or 1 custom point

CONDUCTIVITY

Range	0.000 to 200.000 mS/cm (actual EC up to 400 mS/cm)
Resolution	
Manual	1 μ S/cm; 0.001 mS/cm; 0.01 mS/cm; 0.1 mS/cm; 1 mS/cm
Automatic	1 μ S/cm from 0 to 9999 μ S/cm 0.01 mS/cm from 10.00 to 99.99 mS/cm 0.1 mS/cm from 100.0 to 400.0 mS/cm
Automatic mS/cm	0.001 mS/cm from 0.000 to 9.999 mS/cm 0.01 mS/cm from 10.00 to 99.99 mS/cm 0.1 mS/cm from 100.0 to 400.0 mS/cm
Accuracy	± 1 % of reading or ± 1 μ S/cm whichever is greater
Calibration	automatic 1 point with 6 memorized standards (84 μ S/cm, 1413 μ S/cm, 5.00 mS/cm, 12.88 mS/cm, 80.0 mS/cm, 111.8 mS/cm) or custom point

RESISTIVITY

Range	0 to 999999 Ω /cm; (depending on setup measurement) 0 to 1000.0 k Ω /cm; 0 to 1.0000 M Ω /cm
Resolution	dependent on resistivity reading
Calibration	based on conductivity or salinity calibration

TDS

Range	0 to 400000 mg/L or ppm; (the maximum value depends on the TDS factor)
Resolution	
Manual	1 mg/L (ppm); 0.001 g/L (ppt); 0.01 g/L (ppt); 0.1 g/L (ppt); 1 g/L (ppt)
Automatic	1 mg/L (ppm) from 0 to 9999 mg/L (ppm) 0.01 g/L (ppt) from 10.00 to 99.99 g/L (ppt) 0.1 g/L (ppt) from 100.0 to 400.0 g/L (ppt)
Automatic g/L (ppt)	0.001 g/L (ppt) from 0.000 to 9.999 g/L (ppt) 0.01 g/L (ppt) from 10.00 to 99.99 g/L (ppt) 0.1 g/L (ppt) from 100.0 to 400.0 g/L (ppt)
Accuracy	± 1 % of reading or ± 1 mg/L (ppm) whichever is greater
Calibration	based on conductivity or salinity calibration

SALINITY

Range	0.00 to 70.00 PSU (extended Practical Salinity Scale)
Resolution	0.01 PSU
Accuracy	$\pm 2\%$ of reading or 0.01 PSU whichever is greater
Calibration	1 custom point

SEAWATER SPECIFIC GRAVITY

Range	0.0 to 50.0 σ_t , $\sigma_{0'}$, σ_{15}
Resolution	0.1 σ_t , $\sigma_{0'}$, σ_{15}
Accuracy	± 1 σ_t , $\sigma_{0'}$, σ_{15}
Calibration	based on conductivity or salinity calibration

AMTOSPHERIC PRESSURE

Range	450 to 850 mmHg; 17.72 to 33.46 inHg; 600.0 to 1133.2 mbar; 8.702 to 16.436 psi; 0.5921 to 1.1184 atm; 60.00 to 113.32 kPa
Resolution	0.1 mmHg; 0.01 inHg; 0.1 mbar 0.001 psi; 0.0001 atm; 0.01 kPa
Accuracy	± 3 mmHg within ± 15 °C from the temperature during calibration
Calibration	automatic at 1 custom point

GENERAL CHARACTERISTICS

Temperature compensation	automatic from -5 to 55 °C (23 to 131 °F)
Logging memory	up to 60,000 samples with 13 measurements each*
Logging interval	1 second to 3 hours
Computer interface	USB (with HI 92000 software)
Waterproof Protection	Meter IP 67, Probe IP 68
Environment	0 to 50 °C (32 to 122 °F); RH 100 %
Power supply	4 x 1.5 V alkaline C cells (approximately 150 hours of continuous use, without backlight) 4 x 1.2 V rechargeable C cells (approximately 70 hours of continuous use, without backlight)
Dimensions	
Meter	221 x 115 x 55 mm (8.7 x 4.5 x 2.2")
Probe	l = 270 (10.7"), dia = 46 mm (1.8")
Weight	
Meter	750 g (26.5 oz.)
Probe	750 g (26.5 oz.)

* Without remarks. When using remarks the maximum number of samples decreases but in practical cases it will never be less than 50,000.

1.7 DISPLAY & KEYBOARD DESCRIPTION

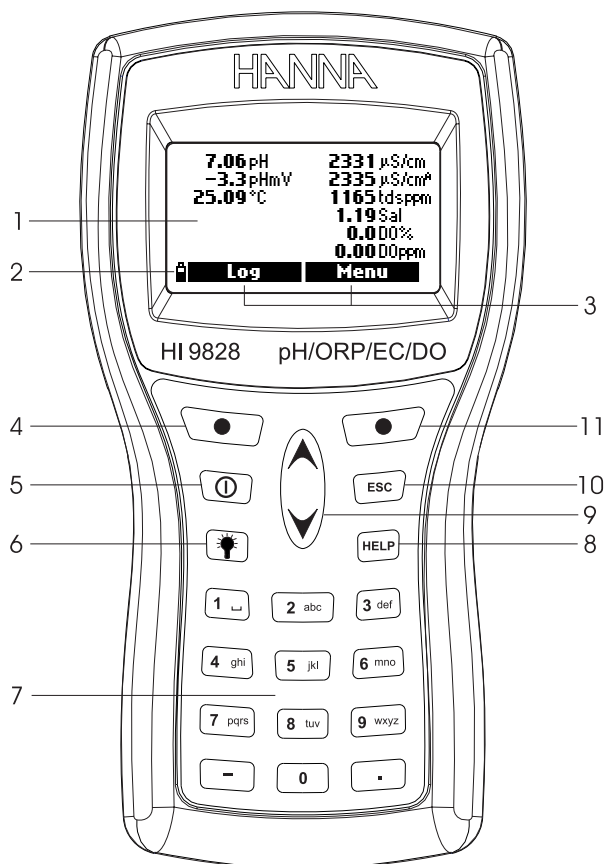

1. Display
2. Indication of battery level
3. Softkey functions
4. Left softkey: function defined on display
5. On/Off key: to turn on and off the meter
6. Backlight: to activate the backlight
7. Alphanumeric keyboard: to insert alphanumeric codes
8. HELP key: to have information about the shown screen
9. Arrow keys: to scroll between options
10. ESC key: to go back to the previous screen
11. Right softkey: function defined on display

1.8 HELP FUNCTION

HI 9828 is provided with the HELP function, useful to have short information regarding the displayed screen. It will be sufficient to press the HELP key and an information window will appear.

For more longer messages press the arrow keys to scroll.

To escape from the help window press again the HELP key.

Chapter 2 - MEASUREMENT MODE

HI 9828 has the possibility to read at the same time different parameters from the same probe. As described in the previous sections it is possible to mount up to 3 sensors on the probe.

2.1 PROCEDURE

- Connect the probe to the meter; remember to fix with care the protection sleeve to the probe.
- Immerse the probe in the sample paying attention to avoid stones.
- Turn on the meter by pressing the On/Off key. The meter visualizes “Hanna HI 9828”, the software version and then it enters measurement mode.
- The meter visualizes the readings relative to all the enabled parameters. See Chapter 3 for more information.
- Press LOG to store the readings or MENU to enter in the main meter menu. See Chapter 5 for more information.

NOTES: If the meter does not find the probe the message “Probe disconnected!” appears. In this case the only available softkey is Menu and it is possible to operate only with the functions that do not require a reading.

It is possible to enable up to 12 parameters. Based on the number of enabled parameters the graphical resolution change, the lower the number of parameters, the bigger the digits size.

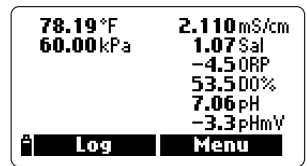
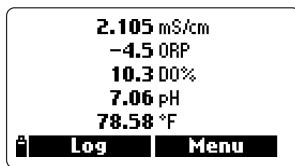
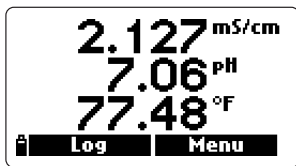

A small A letter added to $\mu\text{S}/\text{cm}$ and mS/cm refers to Actual conductivity, i.e. the conductivity reading without temperature compensation.

When a measure is out of range, the maximum (or minimum) value for the measurement will slowly and continuously blink.

By pressing the lamp key it is possible to turn on/turn off the backlight. After one minute passed without pressing any key, the backlight turns off automatically.

Chapter 3 - SETUP MODE

A few parameters have to be set before taking measurements. In the main menu there are two setup items: Measurement and System setup.

Measurement setup allows to set the displayed readings and their units; system setup allows to set the system parameters, e.g. interface language, date and time, LCD contrast, acoustical signals, etc..

3.1 MEASUREMENT SETUP

- Switch on the meter by pressing the On/Off key.

After initialization, the meter enters measurement mode and the active soft keys are LOG and MENU.

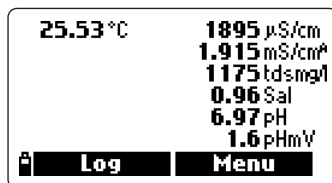

- Press MENU, select *Measurement Setup* with the arrow keys and press OK.



- The display visualizes the complete list of measurable parameters.

- To select a parameter, scroll with the arrow keys to highlight it.

It is possible to enable or disable each parameter. A checked box or the unit measure next to the parameters means that it is enabled. Press the right softkey to enable or disable the parameter.

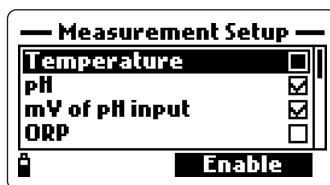
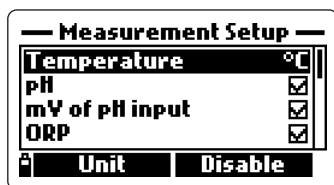

For some parameters it is also possible to select the measure unit and the resolution by pressing the UNIT or RESOLUTION softkey.

Temperature

It is possible to select K, °F and °C.

pH, mV of pH input, ORP, D.O. % saturation, Salinity

These parameters can only be enabled or disabled; the measure unit and the

resolution are fixed.

D.O. concentration

It is possible to select: ppm or mg/l.

Conductivity and Actual Conductivity

It is possible to select: Auto (autoranging both $\mu\text{S}/\text{cm}$ and mS/cm), $1 \mu\text{S}/\text{cm}$, $0.001 \text{ mS}/\text{cm}$, $0.01 \text{ mS}/\text{cm}$, $0.1 \text{ mS}/\text{cm}$, $1 \text{ mS}/\text{cm}$, Auto mS (autoranging in mS/cm unit).

NOTE: Actual conductivity is the conductivity reading without temperature compensation.

Resistivity

It is possible to select: Ω/cm , $\text{k}\Omega/\text{cm}$ or $\text{M}\Omega/\text{cm}$.

TDS

It is possible to select: Auto, autoranging both $\text{ppm}(\text{mg}/\text{l})$ and $\text{ppt}(\text{g}/\text{l})$, $1 \text{ ppm}(\text{mg}/\text{l})$, $0.001 \text{ ppt}(\text{g}/\text{l})$, $0.01 \text{ ppt}(\text{g}/\text{l})$, $0.1 \text{ ppt}(\text{g}/\text{l})$, $1 \text{ ppt}(\text{g}/\text{l})$, Auto $\text{ppt}(\text{g}/\text{l})$ (autoranging in ppt or g/l unit).

NOTE: For setting ppm or mg/l , see paragraph 3.2 System Setup.

Seawater specific gravity

This value is a widely used parameter for seawater; it is similar to density measurement and it is an expression of salts content in water. It depends on atmospheric pressure, temperature and salinity.

In the seawater specific gravity menu it is possible to select the reference temperature: σ_t , σ_{0t} , and σ_{15} . (Current temperature, $t=0^\circ\text{C}$, $t=15^\circ\text{C}$ respectively).

Atmospheric pressure

It is possible to select: atm, kPA, mmHg, inHg, mbar, psi.

NOTE: A maximum of 12 measurements can

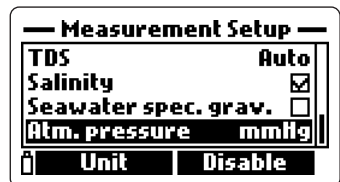
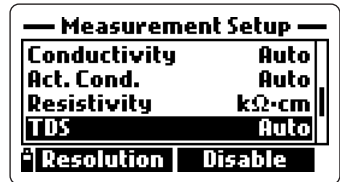
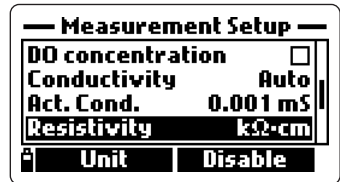
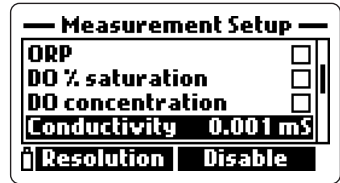
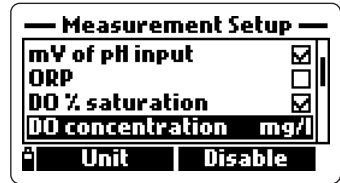

be enabled simultaneously on display. A warning message appears if trying to enable more than 12 measurements.

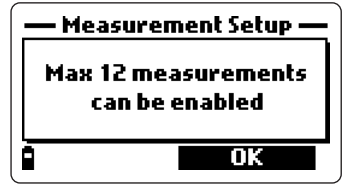

3.2 SYSTEM SETUP

- In measurement mode, press MENU, select *System Setup* with the arrow keys and then press OK.
- To select a parameter, scroll with the arrow keys to highlight it and then press MODIFY.

NOTE: if the password is enabled, it is necessary to insert it prior to change the first parameter.

Language

It is possible to change the display language. The available options are English, Spanish, French, Portuguese and Italian. The language can be modified pressing the MODIFY soft key.

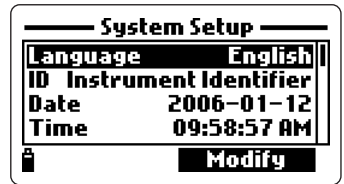

ID

It is possible to insert an identification code for the meter. By pressing MODIFY a textbox appears on display: use the keyboard to insert the desired alphanumeric code and then press OK. (A maximum of 25 characters can be used).

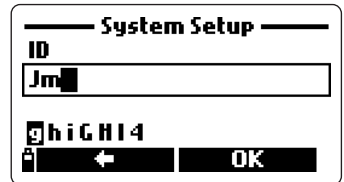

Date

Select the desired date format by pressing repeatedly FORMAT. The available formats are: DD/MM/YYYY, YYYY-MM-DD and MM-DD-YYYY.

Insert the date with the keyboard and then press OK.

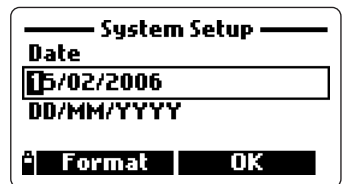

Time

Select the desired format time by pressing repeatedly FORMAT. The available formats are: hh:mm:ss (24 hours) and hh:mm:ss (12 hours).

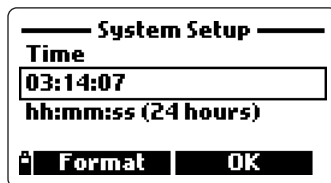
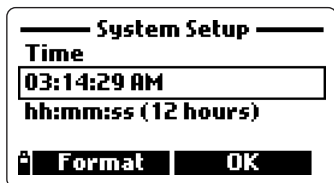

Insert the time with the keyboard and then press OK.

Auto off

The meter shut off automatically if no keys are pressed for the set time. This feature can be disabled or enabled; by pressing the MODIFY soft key it is possible to select the desired option: NO, 5, 10, 15, 20, 30 or 60 minutes.

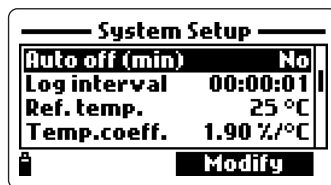

Log interval

Set the logging interval between 1 second and 3 hours.

Reference temperature

For Conductivity readings it is necessary to set the reference temperature for the displayed value. The available options are 20 °C and 25 °C. To set the value press the MODIFY soft key.

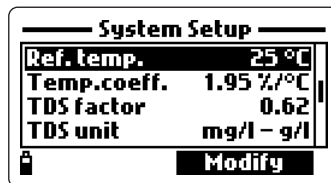

Temperature coefficient

This factor can be set from 0.00 %/°C (no temperature compensation) to 6.00% /°C. To set this value press MODIFY and then insert the desired value with the keyboard. The left arrow soft key allows to shift the cursor. To confirm the value press OK.



TDS factor

The conversion factor can be set from 0.00 to 1.00. Usually for strong ionic solutions the set value is 0.5 and for weak ionic solutions, as nutritive solutions, is 0.7.

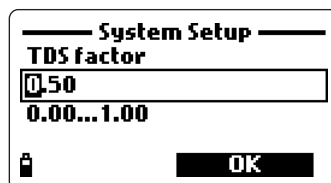

To set this factor press MODIFY, insert the value and then press OK.

TDS unit

TDS readings can be expressed as ppm-ppt or mg/l-g/l. Press MODIFY to select the desired unit.

Average length

In order to obtain an averaged value and a more representative reading with an unstable sample, set the repetition readings number for the displayed values.

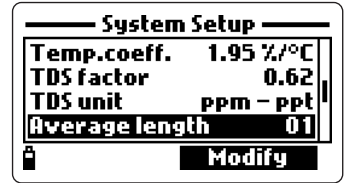

To select the desired average length for readings press MODIFY. The value can be set from 1 to 30.

Key beep

If enabled the meter emits an acoustical signal every time a key is pressed.

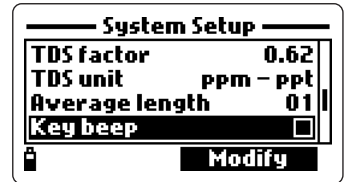

Error beep

If enabled the meter emits an acoustical signal when a wrong key is pressed, or when some particular errors occur.

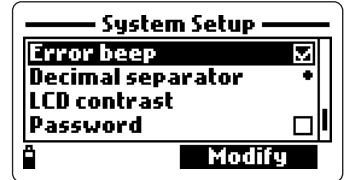

Decimal separator

It is possible to select the type of decimal separator: dot or comma; press MODIFY to select the desired symbol.

LCD contrast

For setting the LCD contrast select the corresponding entry and press MODIFY. An horizontal bar is displayed; press the arrow keys to modify the contrast and then press OK to confirm.

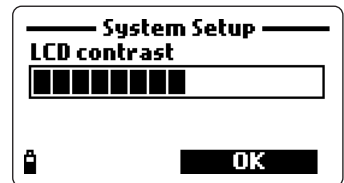

Password

To enable the password:

- Press MODIFY to select the entry.
- Insert the desired password in the textbox and press OK.

NOTE: While typing, the characters are masked with * (star) symbol.

- The meter asks to confirm the password: type again the same password and then press OK.



- The meter returns in the System Setup menu and the checkbox near the password entry is signed.

To disable the password:

- Press MODIFY to select the password entry.
- Insert the password and then press DISABLE. In the textbox appears NO.
- Press OK to confirm.

Restore factory settings

It is possible to reset the *System Setup* and *Measurement Setup* parameters to their default values.

- Select the Restore factory settings entry and press OK.
- The meter asks to confirm: press YES to confirm or NO to escape.

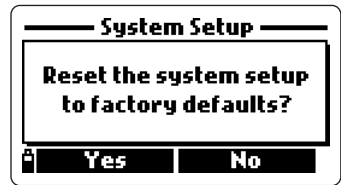

NOTE: It is possible to quit the system setup at any time by pressing ESC. For each entry, if selection was not confirmed, the new setting will not be accepted.

3.3 TABLE OF MEASUREMENT AND SETUP ITEMS

Measurement Setup

<i>Entry</i>	<i>Description</i>	<i>Default value</i>	<i>Valid Values</i>
Temperature	temperature unit	°C	K; °C; °F
pH	pH measure	<input checked="" type="checkbox"/>	<input checked="" type="checkbox"/> ; <input type="checkbox"/>
mV of pH input	mV of pH readings	<input checked="" type="checkbox"/>	<input checked="" type="checkbox"/> ; <input type="checkbox"/>
ORP	redox measure	<input checked="" type="checkbox"/>	<input checked="" type="checkbox"/> ; <input type="checkbox"/>
D.O. % saturation	dissolved oxygen measure	<input checked="" type="checkbox"/>	<input checked="" type="checkbox"/> ; <input type="checkbox"/>
D.O. concentration	dissolved oxygen measure	ppm	ppm; mg/l
Conductivity	electrical conductivity measure	Auto	Auto; 1 μ S; 0.001 mS; 0.01 mS; 0.1 mS; 1 mS; Auto mS
Actual conductivity	no temperature compensated conductivity measure	Auto	Auto; 1 μ S; 0.001 mS; 0.01 mS; 0.1 mS; 1 mS; Auto mS
Resistivity	resistivity measure	M Ω ·cm	M Ω ·cm; k Ω ·cm; Ω ·cm
TDS	total dissolved solids measure	Auto	Auto; 1 ppm; 0.001 ppt; 0.01 ppt; 0.1 ppt; 1 ppt; Auto ppt
Salinity	salinity measure	<input checked="" type="checkbox"/>	<input checked="" type="checkbox"/> ; <input type="checkbox"/>
Seawater specific gravity	specific gravity measure	σ_t	σ_t ; σ_0 ; σ_{15}
Atmospheric pressure	atmospheric pressure measure	<input type="checkbox"/>	<input checked="" type="checkbox"/> ; <input type="checkbox"/>

System Setup

<i>Entry</i>	<i>Description</i>	<i>Default value</i>	<i>Valid values</i>
Language	interface language	English	English, Spanish, French Portuguese, Italian
ID	meter identification code	-	max 25 characters
Date	update calendar	YYYY/MM/DD	YYYY/MM/DD; MM/DD/YYYY; DD/MM/YYYY
Time	update clock	hh:mm:ss (24 hours)	hh:mm:ss (12 hours); hh:mm:ss (24 hours)
Auto off (min)	autoshut-off after a period of non use	5 min	NO; 5; 10; 15; 20; 30; 60 min

Log interval	period between 2 automatic recordings	00:00:01	00:00:01 to 03:00:00
Ref. temp.	reference temperature for conductivity measures	25 °C	20 °C; 25 °C
Temp.coeff.	temperature coefficient for conductivity measures	1.90 %/°C	0.00 to 6.00%/°C
TDS factor	conversion factor from conductivity readings	0.50	0.00 to 1.00
TDS unit	unit measure for TDS	ppm - ppt	ppm - ppt; mg/l - g/l
Average length	readings number	01	1 to 30
Key beep	acoustic signal for pressed key	<input checked="" type="checkbox"/>	<input checked="" type="checkbox"/> ; <input type="checkbox"/>
Error beep	acoustic signal for wrong key pressed	<input checked="" type="checkbox"/>	<input checked="" type="checkbox"/> ; <input type="checkbox"/>
Decimal separator	for number display	.	. ; ,
LCD contrast	contrast for the LCD	8	1 to 15
Password	insert a password	-	max 25 characters

Chapter 4 - CALIBRATION MODE

HI 9828 allows to perform six different types of calibration, one for each parameter and also a quick single point calibration for all the parameters.

The calibration data are memorized in the non volatile probe memory. This function is useful to use the same probe with different meters without the need to recalibrate.

- To perform a calibration, select “Calibration” in the main menu with the arrow keys and then press OK.

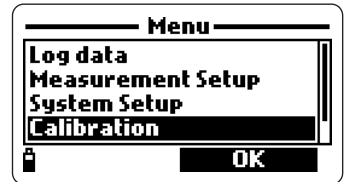

NOTE: If the password is enabled and the latest function shown on display was not a password protected feature, the meter will ask to insert the password.

- Select the type of calibration with the arrow keys and then press OK.

The available options are:

Quick Calibration (allows the D.O. saturation, pH and conductivity calibration with a single point procedure), pH, Dissolved Oxygen, Conductivity, Atmospheric pressure, ORP and Temperature.

4.1 QUICK CALIBRATION

The quick calibration is a feature that allows the user to calibrate the multiparameter probe on the field, with only one solution, HI 9828-25, in a fast and easy way.

- Fill the calibration beaker with HI 9828-25 calibration solution.
- Screw the calibration beaker clockwise on the probe body. Some solution will overflow.
- Wait a few minutes to stabilize.
- In Calibration menu, select Quick calibration and press OK.
- A 3 items (pH, Conductivity and Dissolved Oxygen)screen appears, the pH starts to blink and the “Not ready”message

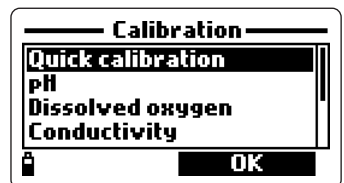

appear.

- When the measure is stable the message “Ready” appears; press CONFIRM to accept the value.

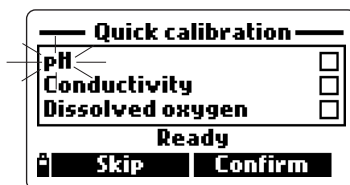
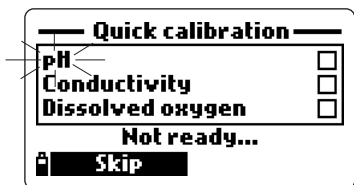

- The messages “Storing data on probe, please wait...” and “Updating GLP data, please wait ...” appear.

NOTE: If the pH calibration is not required, it is possible to skip to the EC quick calibration, by pressing the SKIP soft key.

If the pH sensor is missing the message “pH sensor not installed! Skip to conductivity calibration” appears.

- After pH calibration is confirmed, the EC blinks.

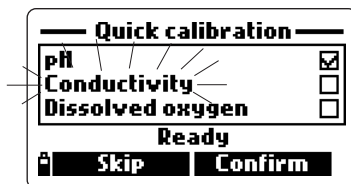

- When the measure is stable the message “Ready” appears; press CONFIRM to accept the value.

- The messages “Storing data on probe, please wait...” and “Updating GLP data, please wait ...” appear.

NOTE: If the EC calibration is not required, it is possible to skip to the DO quick calibration, by pressing the SKIP soft key.

- The meter goes to the DO quick calibration and the message “Empty the beaker. Shake the probe and put it in the beaker again” appears.

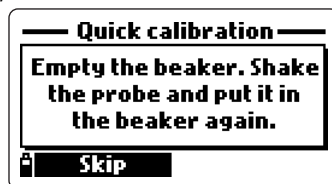

- Unscrew the calibration beaker and remove the solution.

- Shake the probe, similarly to clinical thermometers, to dry it. Pay attention that no drops are present on the DO sensor.

NOTE: Do not use any type of paper to dry the probe to avoid sensor damages.

- Screw back the calibration beaker clockwise on the probe body.
- Wait for reading stability and then press CONFIRM.
- After CONFIRM is pressed the messages “Storing data on probe, please wait...” and “Updating GLP data, please wait ...” appear.
- Then the 3 calibration items screen appears again and the checked box will be full or empty in accordance with the calibrated parameters.
- Press OK to go back to the calibration menu.

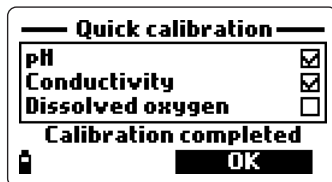

NOTE: To abort the quick calibration press ESC at any time.

4.2 pH CALIBRATION

Calibrate the meter often, especially if high accuracy is required.

Selecting pH calibration, the display shows two possibilities: “Calibrate pH” and “Clear old calibration”.

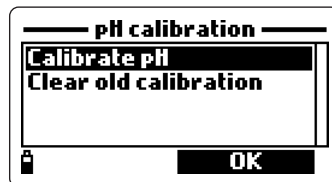

By selecting “Calibrate pH” and pressing OK, it is possible to start a new calibration at 1, 2 or 3 points with standard buffers (pH 4.01, 6.86 or 7.01, 9.18 or 10.01) or a 1 point calibration with a custom buffer.

By selecting “Clear old calibration” and pressing OK, it is possible to delete the calibration data and restore the default data.

NOTES: It is important to delete old calibration data every time the pH electrode is replaced and after a cleaning procedure.

When a 3-point calibration is performed all the old data are overwritten. If a 1 or 2-point calibration is performed, for the missing values the meter will use the old data, stored in previous 3-point calibration.

4.2.1 Preparation

Pour small quantities of the buffer solutions into clean beakers. If possible, use plastic beaker to minimize any EMC interferences. For accurate calibration and to minimize cross contamination, use two beakers for each buffer solution. One for rinsing the electrode and the second for calibration.

4.2.2 Procedure

During calibration the current measured value is shown on the primary display and the buffer value on the secondary display.

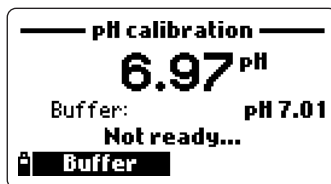

By pressing the BUFFER soft key it is possible to change the buffer value or insert a custom buffer.

One to three-point calibration

- Immerse the probe into the selected buffer and stir gently. On display the current pH value, the buffer value and the message "Not ready" appear.

- When the reading is stable and close to the selected buffer the display shows "Ready".

- Press CONFIRM to accept the value or BUFFER to select another buffer value with the arrow keys.

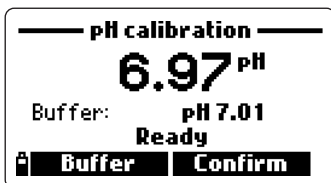

- After the first calibration point is confirmed, immerse the probe in the second buffer solution and stir gently.

- When the reading is stable and close to the selected buffer the display shows the message "Ready".

- Press CONFIRM to accept the value or BUFFER to change the buffer value.

- After the second calibration point is confirmed, proceed as above by immersing the probe in the third buffer solution, stirring gently and waiting for the measure stability.

- At the end of calibration on display the following messages appear: "Storing data on probe, please wait...", "Updating GLP data, please wait ..." and "Calibration completed".

- Press OK to close the last message and return to the calibration menu.

- To return to the main menu, from the calibration menu, press ESC repeatedly.

NOTE: the user can quit the pH calibration mode at any time, after 1 or 2 confirmed buffers, by pressing the ESC key.

Custom buffer calibration

HI 9828 allows a one point calibration with a custom buffer value, set by the

user.

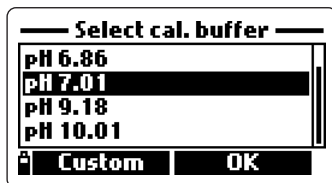

- To select this option, when the meter is waiting for a stable measure, press the BUFFER key and then CUSTOM.

- The display shows a window with a textbox for inserting the desired custom value. The valid range for custom buffers is from 0.00 to 14.00 pH.

4.2.3 Error list

If during pH calibration the measure is stable but the meter does not accept the value, on display a short message appears, indicating the possible error source, like in these examples:

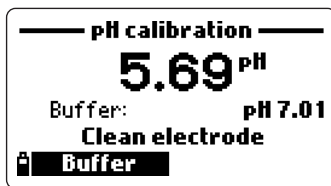
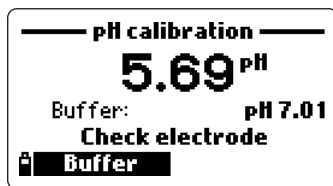
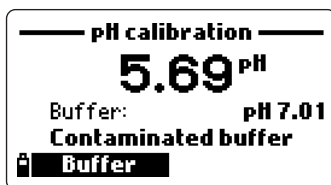
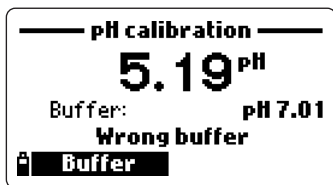

Possible messages are:

“Input out of scale”: pH is out of scale

“Wrong buffer”: this message appears when the difference between the pH reading and the value of the selected buffer is too big. If the error message is displayed, check if you have selected the proper calibration buffer.

“Invalid temperature”: this message appears if the temperature of the buffer is outside the defined buffer temperature range.

“Wrong & contaminated buffer/ check electrode”: this message appears if the buffer used is contaminated or the electrode is supposed to be either broken or very dirty.

“Wrong & check electrode/ clean electrode”: this message appears if the electrode is supposed to be broken or very dirty.

“Wrong & clear old calibration”: this message appears as a result of an erroneous slope condition. If the slope between current calibration point and one of the previous calibration, that was not overridden in current calibration, exceeds slope window (80% to 110%), this message will appear. Also, a CLEAR softkey will appear on the right. Press CLEAR to clear old parameters and continue calibration process or ESC to leave calibration.

4.3 DISSOLVED OXYGEN CALIBRATION

If D.O.% saturation range is calibrated, D.O. concentration range will be calibrated too, and viceversa.

The D.O. % saturation value is the result of a comparison between the concentration of oxygen in air (100 %) and in water, so it is suggested to calibrate the probe near the area where the measurements will be taken in order to have the best accuracy.

Note also that the D.O. concentration values are based on D.O. % saturation, temperature, salinity and atmospheric pressure so it is recommended to use a standard solution or a reference D.O. meter to compare readings during calibration.

D.O. % saturation calibration can be performed at 1 or 2 standard points (0 % and 100 %), or at a single custom point (50 to 500 %).

D.O. concentration calibration can be performed at a single custom point (4 to 50 mg/L).

4.3.1 Procedure

After choosing the D.O. calibration mode in the main calibration menu, select the type of calibration with the arrow keys and then press OK.

D.O. % saturation

This calibration starts by default with 100 %.

- Fill the probe beaker with approximately 4 mm (5/32”) distilled water and screw it on the probe.
- The message NOT READY appears until the value is stabilized.
- To change standard calibration point, press CAL.POINT.

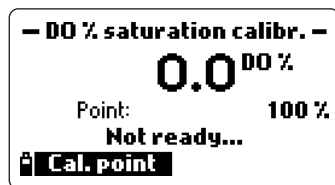
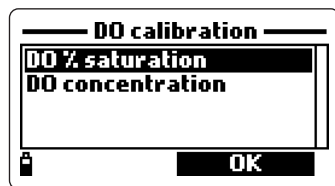

- To insert a different calibration value, after pressing CAL. POINT, press also CUSTOM and insert the desired value with the keyboard.

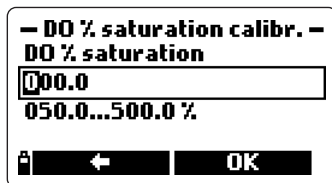

- When the reading is stable READY and CONFIRM appear. Press CONFIRM to accept the calibration point.

- After the first calibration point is confirmed, put the probe in a D. O. 0% saturation standard solution and wait until the measure is stable.

- Press CONFIRM to accept the calibration point.

- At the end of calibration the following messages appear: "Storing data on probe, please wait...", "Updating GLP data, please wait ..." and "Calibration completed".

- Press OK to return to the calibration menu.

- To return to the main menu, from the calibration menu, press ESC repeatedly.

NOTES: The user can perform a single point calibration with standard values

To abort the calibration after first point is accepted, press ESC.

If the D.O. input is not within the acceptable range, the message "INVALID INPUT" will be shown.

D.O. concentration

To calibrate the D.O. concentration, it is necessary a solution with known concentration.

- In D.O. calibration menu, select DO concentration.

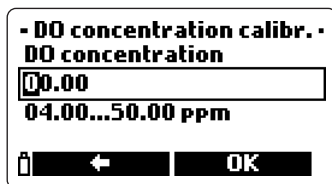

- Insert the known value and press OK.

- When the reading is stable, CONFIRM appears; press CONFIRM to accept the value.

- When the messages "Storing data on probe, please wait...", "Updating GLP data, please wait ..." and "Calibration completed" appear the calibration is completed and the user can return to the main calibration menu by pressing OK or to the main menu by pressing ESC repeatedly.

4.4 CONDUCTIVITY CALIBRATION

For a correct conductivity calibration the probe sleeve must be always inserted.

The conductivity calibration menu offers 3 different type of calibration: Conductivity, Actual conductivity and Salinity.

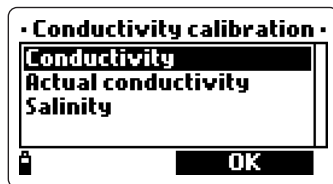

Conductivity option allows a 1 point calibration with a standard solution selectable by the user. This calibration is temperature compensated.

The “Actual conductivity” option allows a custom calibration with a known actual conductivity solution (not temperature compensated). This option is useful for calibrating without knowing the temperature effects on readings.

The “Salinity” option allows calibrations with a standard salinity solution.

The 3 ranges are related, if one of them is calibrated, the other two are calibrated too.

4.4.1 Procedure

After choosing the conductivity calibration mode in the main calibration menu, select the type of calibration with the arrow keys and then press OK.

Conductivity

- Fill a beaker with a standard conductivity solution (see ACCESSORIES section).
- Immerse the probe with its sleeve in the solution and wait for the measure stability.
- The meter shows on the primary display the actual reading and on the secondary display the standard value.

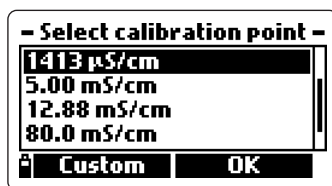
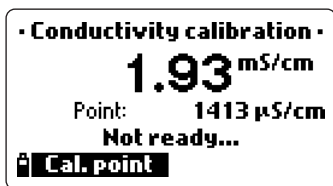

- To change the standard value, press CAL. POINT. On display appear the possible values of standard solutions. The available values are: $84\mu\text{S}/\text{cm}$, $1413\mu\text{S}/\text{cm}$

cm, 5.00 mS/cm, 12.88 mS/cm, 80.0 mS/cm and 111.8 mS/cm.

- By pressing CUSTOM it is also possible to insert a custom value and resolution (compensated conductivity value).
- When the reading is stable, press CONFIRM to accept the value.
- After confirmation, on display appear the following messages: "Storing data on probe, please wait ...", "Updating GLP data, please wait ...", "Calibration complete".
- Press OK to close the last message and return to the main calibration menu.
- To return to the main menu, from the calibration menu, press ESC repeatedly.

Actual Conductivity

- Select the Actual Conductivity option and press OK.
- Insert the custom value and set its resolution.
- Immerse the probe with its sleeve in the conductivity solution and wait for the reading stability.

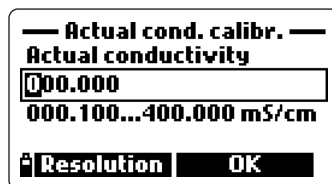

- When the reading is stable, press CONFIRM to accept the value.
- Press OK or ESC to return to calibration or main menu respectively.

Salinity

Select the Salinity option and press OK.

- Insert the custom value and set its resolution.
- Immerse the probe with its sleeve in the known solution and wait for the reading stability.
- When the reading is stable, press CONFIRM to accept the value.
- Press OK or ESC to return to calibration or main menu respectively.

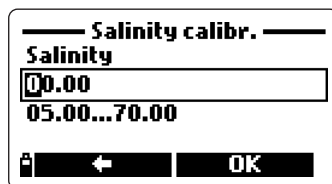

NOTES: These 3 types of calibration set the slope values. To calibrate the offset, repeat the procedure with the calibration point set at 0 μ S/cm.

If the temperature input is not within the acceptable range (0-50 °C), the message "Invalid temperature" will be shown.

If the conductivity input is not within the acceptable range, the message "INVALID INPUT" will be shown.

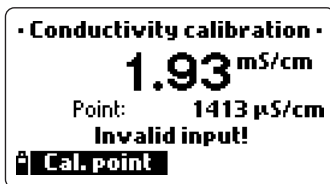

4.5 ATMOSPHERIC PRESSURE

A reference barometer is needed. During calibration, a maximum difference of 40 mbar between current reading and the calibration point is allowed.

4.5.1 Procedure

After choosing the Atmospheric pressure calibration mode in the calibration menu, select the type of calibration with the arrow keys and then press OK.

- Select the unit measure and insert the pressure value with the keyboard.
- Press OK and wait for the measure stability.
- When the reading is stable, press CONFIRM to accept the value.
- Press OK or ESC to return to calibration or main menu respectively.
- To restore the factory calibration, select this option in the pressure calibration menu and then press OK.

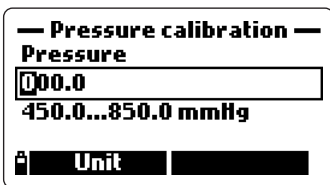
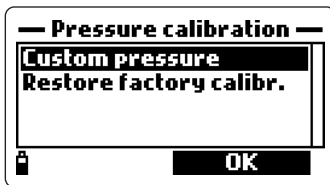

4.6 ORP CALIBRATION

It is possible to calibrate at one custom point or restore the factory calibration.

4.6.1 Procedure

- Fill a beaker with a ORP solution (see ACCESSORIES chapter).
- Select "CUSTOM ORP" and press OK.
- With the keyboard insert the value of solution and press OK.
- When the measure is stable, press CONFIRM to accept the calibration.

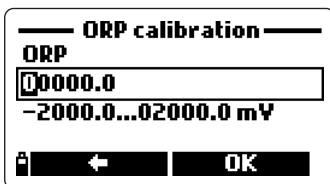

Press OK or ESC to return to calibration or main menu respectively.

- To restore the factory calibration, select this option in the calibration menu and then press OK.

4.7 TEMPERATURE CALIBRATION

The meter is factory calibrated for temperature.

If necessary, temperature calibration may be performed as follows.

4.7.1 Procedure

- Insert the probe in the thermoregulated bath.
- Select Temperature in the main calibration menu of the meter and press OK to enter the temperature calibration.
- Select the unit temperature measure ($^{\circ}\text{C}$, $^{\circ}\text{F}$ or K) and insert the bath temperature (read by a reference thermometer).
- When the reading is stable READY and CONFIRM appear on the display.
- Press CONFIRM to accept the calibration.
- On display the following messages appear: "Storing data on probe, please wait ..." "Updating GLP data, please wait ..." "Calibration complete".
- Press OK to close the last message and return to the calibration menu.
- To return to the main menu, from the calibration menu, press ESC repeatedly.

NOTE: The meter allows $\pm 2^{\circ}\text{C}$ maximum difference between current reading and set value. If this condition is not satisfied, the message "Max +/-2 $^{\circ}\text{C}$ is allowed" will appear.

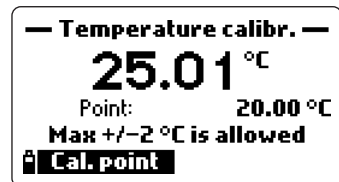
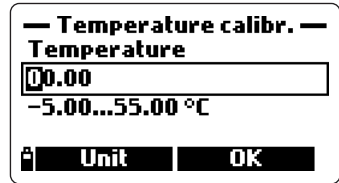

Chapter 5 - LOGGING MODE

HI 9828 can memorizes up to 60,000 samples in 100 different lots. The value 60,000 is reached when no remarks are used. When using remarks, the maximum number of measurements decreases, but in practical cases it will never be less than 50,000.

5.1 LOGGING

- When in measurement mode, press LOG to memorize the enabled readings.
- The meter asks where to store the readings. Press OK to accept the proposed lot.
- The display shows "SAMPLE LOGGED" and returns to measurement mode.

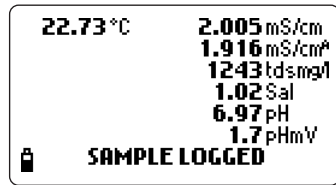
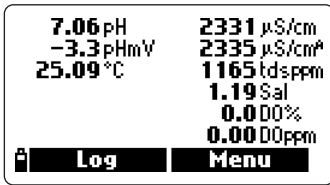

5.1.1 Logging options

• To insert other information related to the logged value or to select the continuous logging mode, press OPTIONS and a sequence of questions appears:

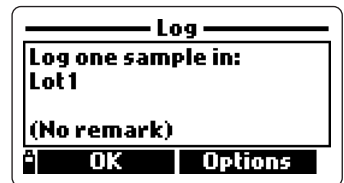

• Logging type, ONE SAMPLE or CONTINUOUS: press one of these soft keys to select the desired option.

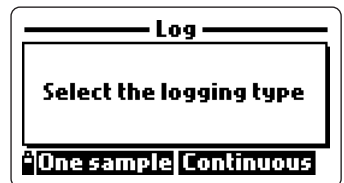

• Where to save the readings: scroll with the arrow keys to select an existing lot and press OK to accept or press NEW LOT to create a new lot; a textbox appears for inserting the desired code. Use the keyboard to insert the code and then press OK.



If the inserted code already exists, the message "The file already exists! Insert a

different file name” appears. Press OK to insert a different name.

- Add a remark: press YES or NO. If YES is pressed and a remark list already exists, it is possible to select the desired annotation or press NEW to insert a new remark; a textbox appears for inserting a note for the logged sample.

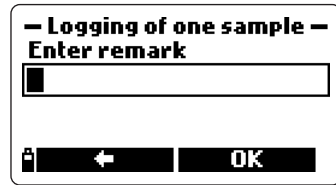
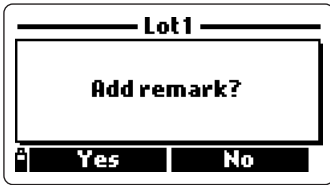

- Tag reading: the last option allows to associate the logged sample to a tag. "Touch the tag with the tag reader" appears. Press SKIP if no tags are available.

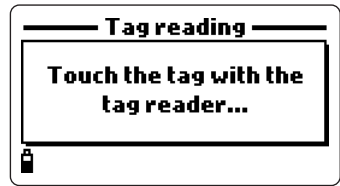

- Touching the tag the relative ID appears. If no ID is associated to the tag, the serial number appears.
- Press TAG ID to insert an identification code for the used tag and then press OK.

NOTES: It is possible to create the logging list and the relative remarks before taking measurements and logging. See paragraph 5.2 Log data Setup.

It is possible to abort the logging procedure at any time, by pressing the ESC softkey repeatedly.

In case of continuous logging, the data collection will start after the last options will be confirmed instead of a single log where the data will be stored after LOG is pressed.

5.2 LOG DATA SETUP

To set lots, insert remarks, review logged or plotted data and also to delete lots, from the main menu select LOG DATA with the arrow keys.

A list of available functions appears.

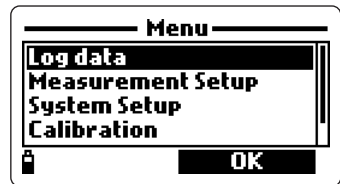

5.2.1 Lots

This option allows to insert a new lot or to select the lot where to memorize the next sample.

- Scroll with the arrow keys to select the desired lot and then press OK.

- Alternatively press NEW LOT to create a new lot and insert its identification name. A textbox appears, with the keyboard insert the desired name. Press OK to confirm.

NOTE: in the upper line of display the meter visualizes the percentage of free memory space, for example Data lots (free:100%).

- After OK is pressed, the meter visualizes all the data referring to the selected lot: samples number, memory space used, time and date of first and last reading.

- By pressing OPTIONS, a 3 options screen appears:

VIEW to visualize the readings relative to the indicated lot; PLOT to visualize the corresponding graph; DELETE to delete the selected lot.

NOTE: the first line of the 3-option screen reports the lot name.

View

- By pressing VIEW the samples details are displayed. Press the arrow keys to change sample number in the selected lot. The sample number is on the down right corner of the display.

- Press INFO to visualize the number of sample, time and date, remark and tag ID or serial number (when present).

- Press DATA to go back to the previous screen or JUMP to select another sample in the same lot. If JUMP is pressed a textbox appears; insert the desired sample number.

- Press ESC to go back to the 3-option menu.

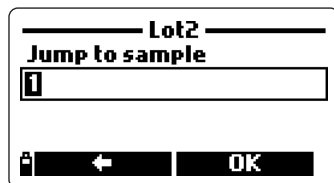
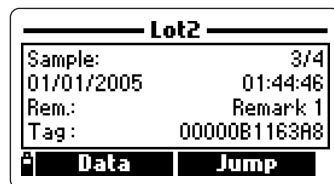
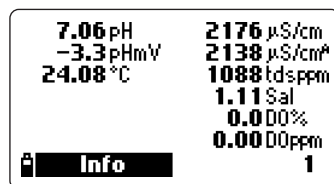
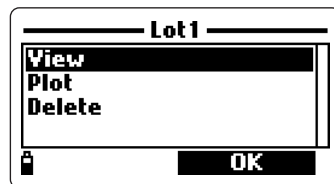
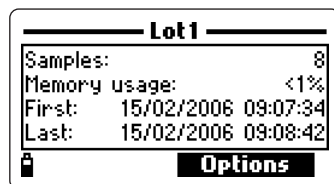
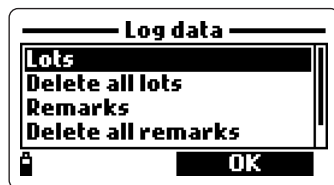

Plot

- By pressing PLOT the complete list of the lot parameters appears.
- Scroll with the arrow keys to select the desired parameter and then press OK to visualize the graph.
- With the arrow keys it is possible to move the cursor to highlight a sample of the lot; the sample data are displayed below the graph.
- Press ESC to go back to the parameters list.
- Press again ESC to go to the 3 options menu.

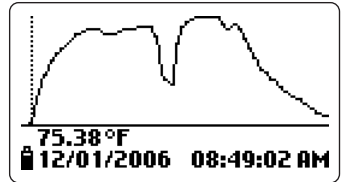
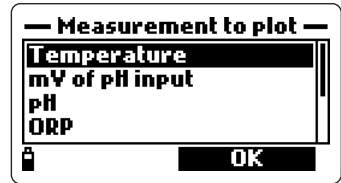

Delete

- The message "The selected lot will be erased! Continue?" appears; press YES to delete or NO to go back to the previous screen.

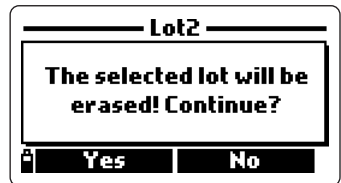

NOTE: To go back to the LOG DATA menu press ESC repeatedly.

5.2.2 Delete all lots

- The message "All stored log data will be erased! Continue?" appears; press YES to delete or NO to go back to the previous screen.

5.2.3 Remarks

It is possible to associate a remark to every sample.

- To add a remark, scroll with the arrow keys to highlight the entry REMARKS and press OK.
- Press NEW to insert a new remark; a textbox, where it is possible to insert the desired information, appears.
- Press DELETE to cancel an existing remark.

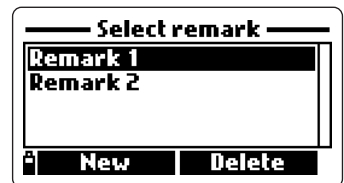

NOTE: During logging it is possible to associate the reading to a remark selected from the previously created remarks list or to a new remark. See paragraph 5.1.1 "Logging options".

5.2.4 Delete all remarks

- To delete all the inserted remarks, select with the arrow key the relative entry and press OK. On display the message “All stored remarks will be erased! Continue?” appears; press YES to delete or NO to go back to the previous screen.

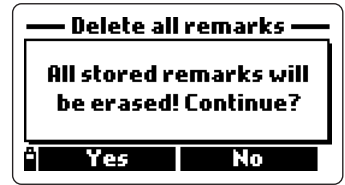

5.2.5 Tags

Read tag

- Select READ TAG to associate the reading to the touched tag; after a few seconds the tag information appears.

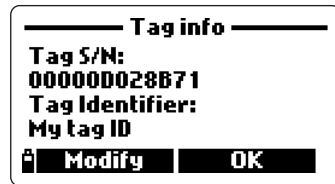
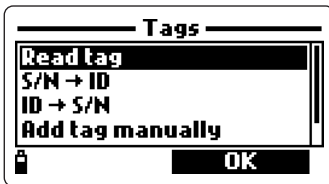

Press MODIFY to change the tag info or press OK to accept.

S/N→ ID

In this menu it is possible to view the ID code associated to a tag serial number.

- Select S/N→ID and press OK.
- With the keyboard insert the serial number and then press OK.
- The tag info screen appears. Press OK to go back to the previous screen or MODIFY to modify the tag ID.

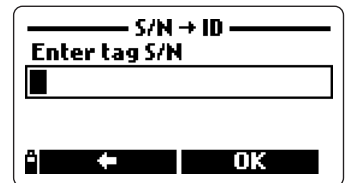

- If the typed S/N is not stored in memory, the warning message “This tag S/N is not stored in memory” appears.

ID→ S/N

In this menu it is possible to view the tag serial number related to an ID.

- Select ID→S/N and press OK.



- With the keyboard insert the identification number and then press OK.
- The tag info screen appears. Press OK to go back to the previous screen or MODIFY to modify the tag ID.

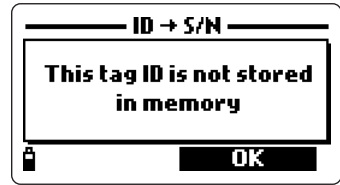

NOTE: If the inserted ID is not present in the memory, a warning message appears.

Add tag manually

It is possible to add a new tag to the list even if the tag is not available.

- Select the option and press OK.
- Insert the tag serial number with the keyboard and then press OK.



Clear tag memory

It is possible to clear completely the tag memory.

- Select the "Clear tag memory" entry and press OK.
- The message "All tag identifiers will be erased. Continue?" appears.
- Press YES to erase or NO to go back to the previous screen.

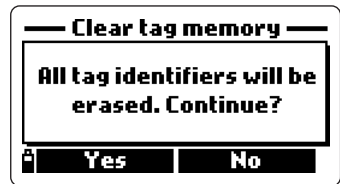

To go back to measurement mode press ESC repeatedly.

Chapter 6 - GLP

GLP (Good Laboratory Practice) is a set of functions that allows the storage or retrieval of data regarding the probe calibration.

This feature allows also to associate a reading to “certified data” (standard solutions, reference meters, etc.) put in the meter through the calibration procedure.

To visualize GLP data, while in measurement mode, press the MENU soft key and scroll with the arrow key to highlight the “GLP data” entry.

The complete list of available parameters appears; highlight the desired entry with the arrow keys and press OK to visualize the relative information.

NOTE: When there are no available calibration data for the selected parameter, the message “No GLP data available for this measurement” appears. Press OK to go back to the previous screen.

6.1 PROBE INFORMATION

- To visualize the probe information, highlight the entry and press OK.
- The probe information appear: model, firmware version, ID and serial number.
- Press OK to go back to the previous screen or MODIFY ID to change the identification code.
- By pressing MODIFY ID a textbox appears: use the keyboard to change the code and then press OK.
- The messages “Storing data on probe, please wait...” and “Data successfully stored on probe” appear.
- Press OK to go back to the Probe information screen.

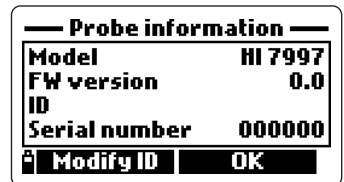
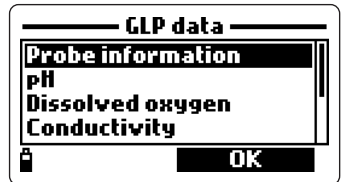
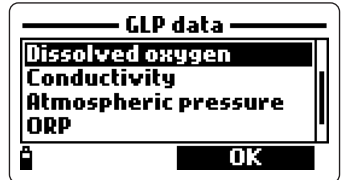

NOTES: If no probe is connected a warning message appears.

To escape without changing press ESC to go back to the previous screen.

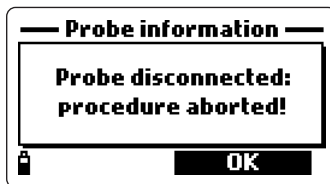

6.2 pH

- From the GLP data main menu, select the pH entry and press OK.
- All the information relative to the last pH calibration appears: offset, acidic slope, basic slope, used buffers, time and date of procedure.
- With the arrow keys it is possible to scroll the last 5 calibration data memorized.

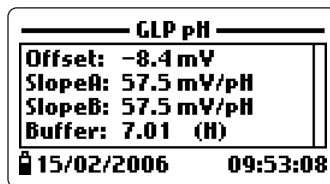

NOTES: The C letter near the buffer value indicates a custom point and the H letter is for Hanna standard values.

If a quick calibration was performed the buffer values are replaced with Quick calibration.

If calibration was cleared, the values for offset and slope are the default values and the message "Old calibration cleared" appears.

- Press ESC to go back to the GLP data main menu.

6.3 DISSOLVED OXYGEN

- From the GLP data main menu, select the Dissolved Oxygen entry and press OK.
- All the information relative to the last DO calibration appear: calibrated points, % saturation or concentration, time and date.
- With the arrow keys it is possible to scroll the last 5 memorized calibrations.

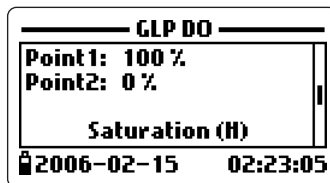

For D.O. GLP calibration data 3 screen types are possible: one for a 2-point percentage D.O. calibration, one for a 1 point percentage D.O. calibration and one for a concentration D.O. calibration.

NOTES: The C label near the calibration points is for custom and the H is for Hanna.

When D.O. percentage saturation is calibrated, also D.O. concentration is calibrated as a result and viceversa.

6.4 CONDUCTIVITY

- From the GLP data main menu, select Conductivity entry and press OK. In this menu it is possible to visualize calibration data for conductivity, actual conductivity and salinity.

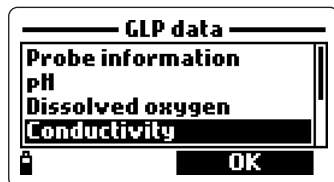

- All the information relative to the last Conductivity calibration appear: the calibrated point, the cell constant value, the calibration type (conductivity, actual conductivity or salinity), time and date.

- With the arrow keys it is possible to scroll between the last 5 memorized calibrations.

For Conductivity GLP calibration data different screen types are possible: conductivity, actual conductivity and salinity.

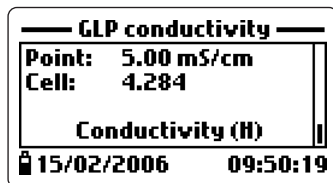
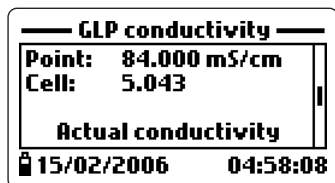

NOTES: The C label near the calibration point is for custom and the H is for Hanna.

6.5 ATMOSPHERIC PRESSURE

- From the GLP data main menu, select the Atmospheric pressure entry and press OK.

- All the information relative to the last Atmospheric pressure calibration appear: custom calibration point, time and date; the message "Factory calibr. restored" in case of restoring factory calibration data.

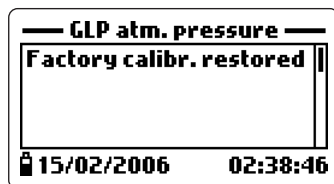

- With the arrow keys it is possible to scroll between the last 5 memorized calibrations.

6.6 ORP

- From the GLP data main menu, select the ORP entry and press OK.
- All the information relative to the last ORP calibration appear: calibrated point, time and date; the message "Factory calibr. restored" in case of restoring factory calibration data.

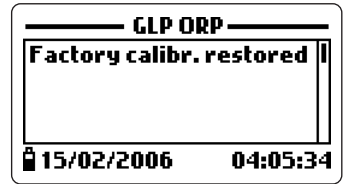

- With the arrow keys it is possible to scroll the last 5 memorized calibrations.

6.7 TEMPERATURE

- From the GLP data main menu, select the Temperature entry and press OK.
- All the information relative to the last temperature calibration appear: calibrated point, time and date.

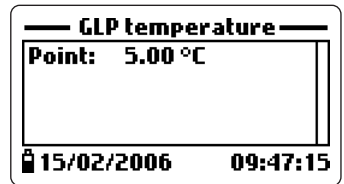

- With the arrow keys it is possible to scroll the last 5 memorized calibrations.

Chapter 7 - PC CONNECTION MODE

The logged data can be transferred to PC by means of the USB connector HI 7698281 and the HI 92000 Windows® compatible application software.

HI 92000 allows you to use the powerful capabilities of most spread sheet programs (e.g. Excel®, Lotus 1-2-3®). Simply open your file downloaded by HI 92000 from your spread sheet program and then it is possible to make any elaboration available with your software (e.g. graphics, statistic analysis). HI 92000 offers a variety of features and has an on line help to support you throughout any situation.

7.1 SOFTWARE INSTALLATION

- Insert the CD into the corresponding PC drive.
- The software menu window should start automatically; (If it does not, go to the folder "software" in the CD and double-click "setup.exe"); click "Install software" and follow the instructions.

7.2 PC CONNECTION

- With the meter OFF, disconnect the probe.
- Connect the USB cable to the meter and to the USB port on PC.
- Turn ON the meter; the message "PC connection" appears.
- Run the HI 92000 application software, select the number COM port within the "Settings window" and then press CONNECT.
- HI 92000 downloads the logged data and on the PC monitor a window with the GLP data and a window with the logged lot will appear.
- On the meter display, during download, the percentage of transferred data is visualized.

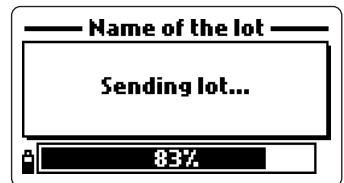

NOTE: To verify the USB number port, after cable connected, press START in the task bar of Window®.

In the main menu select "Settings" and then "Control panel", "System", "Hardware", "Device Manager" and "Ports". In this last menu near USB port there will be the COM number.

HI 92000 - 3.37

Settings Diagnostics Set up Save Exit

Instrument status

Lot name	Temp.	pH	ORP	Cond.	DO	Pres.
1 02161720	Yes	Yes	Yes	Yes	Yes	Yes
2 20000215 1145ca	Yes	Yes	Yes	Yes	Yes	Yes
3						
4						
5						
6						
7						
8						
9						
10						
11						
12						
13						
14						
15						

Probe information
ID: adkade
Serial number: 000000

Temperature
No GLP data available for this measurement

pH
15/02/2006 15:20:14
Offset: -11.3 mV Slope: 57.5 mV/pH Slope: 57.5 mV/pH
Quick calibration
15/02/2006 15:14:47
Offset: -11.3 mV Slope: 57.5 mV/pH Slope: 57.5 mV/pH
Quick calibration
01/01/2006 00:45:41
Offset: 0.0 mV Slope: 57.5 mV/pH Slope: 57.5 mV/pH
Old calibrations cleared
01/01/2006 00:46:03
Offset: -10.7 mV Slope: 57.5 mV/pH Slope: 57.5 mV/pH
Quick calibration
01/01/2006 00:59:02
Offset: 0.0 mV Slope: 57.5 mV/pH Slope: 57.5 mV/pH
Old calibrations cleared

ORP
01/01/2006 13:09:15
Factory table restored

Conductivity
15/02/2006 15:20:44
Quick calibration Cell 5.244
15/02/2006 15:15:31
Quick calibration Cell 5.310
01/01/2006 00:45:33
Quick calibration Cell 5.175
01/01/2006 00:38:47
Quick calibration Cell 5.531
01/01/2006 00:38:44
Quick calibration Cell 5.541

Dissolved oxygen
01/01/2006 02:35:02

Connected

Stop Abort HI 9200

HI 92000 - 3.37

Settings Diagnostics Set up Save Exit

Instrument status

Lot name	Temp.	pH	ORP	Cond.	DO	Pres.	Size (KB)
1 02161720	Yes	Yes	Yes	Yes	Yes	Yes	41
2 20000215 1145ca	Yes	Yes	Yes	Yes	Yes	Yes	143
3							
4							
5							

Probe information
ID: adkade
Serial number: 000000

GLP

20060215 1145ca

Date	Time	°C	pH	pH mV	ORP	DO %	DO ppm	µS/cm	µS/cm A	TDS ppm	Size	
1	2006-02-15	11:46:52	22.87	7.06	-3.3	222.8	0.9	0.00	5042	4836	2521	
2	2006-02-15	11:47:12	22.86	7.06	-3.3	222.8	0.9	0.00	5041	4836	2521	mV/pH
3	2006-02-15	11:47:32	22.84	7.06	-3.3	222.8	0.9	0.00	5042	4836	2521	
4	2006-02-15	11:47:52	22.82	7.06	-3.3	222.8	0.9	0.00	5044	4836	2522	mV/pH
5	2006-02-15	11:48:12	22.82	7.06	-3.3	222.8	0.9	0.00	5045	4836	2523	
6	2006-02-15	11:48:32	22.82	7.06	-3.3	222.8	0.9	0.00	5045	4836	2523	mV/pH
7	2006-02-15	11:48:52	22.81	7.06	-3.3	222.8	0.9	0.00	5044	4834	2522	
8	2006-02-15	11:49:12	22.79	7.06	-3.3	222.8	0.9	0.00	5046	4836	2523	mV/pH
9	2006-02-15	11:49:32	22.79	7.06	-3.3	222.8	0.9	0.00	5046	4836	2523	
10	2006-02-15	11:49:52	22.79	7.06	-3.3	222.8	0.9	0.00	5048	4836	2524	mV/pH
11	2006-02-15	11:49:12	22.79	7.06	-3.3	222.8	0.9	0.00	5046	4836	2523	
12	2006-02-15	11:50:32	22.78	7.06	-3.3	222.8	0.9	0.00	5048	4836	2524	mV/pH
13	2006-02-15	11:50:52	22.76	7.06	-3.3	222.8	0.9	0.00	5050	4836	2525	
14	2006-02-15	11:51:12	22.76	7.06	-3.3	222.8	0.9	0.00	5050	4836	2525	mV/pH
15	2006-02-15	11:51:32	22.76	7.06	-3.3	222.8	0.9	0.00	5049	4834	2525	
16	2006-02-15	11:51:52	22.76	7.06	-3.3	222.8	0.9	0.00	5052	4837	2526	mV/pH
17	2006-02-15	11:52:12	22.76	7.06	-3.3	222.8	0.9	0.00	5050	4836	2525	
18	2006-02-15	11:52:32	22.76	7.06	-3.3	222.8	0.9	0.00	5050	4836	2525	mV/pH
19	2006-02-15	11:52:52	22.76	7.06	-3.3	222.8	0.9	0.00	5091	4836	2525	
20	2006-02-15	11:53:12	22.77	7.06	-3.3	222.8	0.9	0.00	5049	4836	2525	mV/pH
21	2006-02-15	11:53:32	22.77	7.06	-3.3	222.8	0.9	0.00	5049	4836	2525	
22	2006-02-15	11:53:52	22.77	7.06	-3.3	222.8	0.9	0.00	5049	4836	2525	mV/pH

Dissolved oxygen
01/01/2006 02:35:02

Connected

Stop Abort HI 9200

Chapter 8 - MESSAGES & ERRORS

HI 9828 visualizes a series of messages if probe or meter errors are generated. Please take note of their significance and solution. For quick information the help menu is always available on the meter.

- “Continuous logging - Flash memory is full”: this message appears when the memory is full and it is not possible to log other readings. Press OK and delete some records.

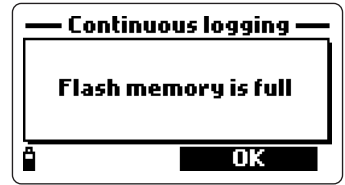

- “Continuous logging - Flash memory error!”: this message appears when there is a memory error; press OK, download the data and delete all lots. If the problem persists contact the nearest Hanna Center.

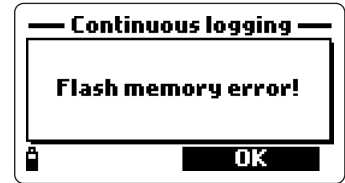

- “Probe communication error!”: this message appears when there is a communication problem between probe and meter; verify connector and cable; turn off the meter, disconnect and re-connect the probe. If the problem persists contact the nearest Hanna Center.



- “Probe critical error: EEPROM corruption!”: this message appears when the EEPROM data are corrupted; turn off the meter, disconnect and re-connect the probe. If the problem persists contact the nearest Hanna Center.

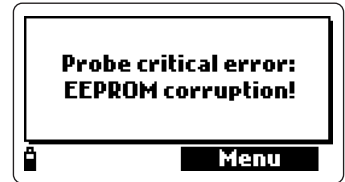

- “Probe critical error: ADC blocked!”: this message appears when the A/D converter does not respond or is blocked; turn off the meter, disconnect and reconnect the probe. If the problem persists contact the nearest Hanna Center.



- “Probe critical error: I2C bus fault!”: this message appears when an internal transmission is not acknowledged or a bus fault occurs for more than a certain number of unsuccessful transmission attempts; turn off the meter, disconnect and



reconnect the probe. If the problem persists contact the nearest Hanna Center.

- "Probe critical error": this message appears when there is a probe error than is not related to the previous; turn off the meter, disconnect and reconnect the probe. If the problem persists contact the nearest Hanna Center.

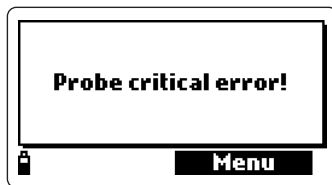

- "None of the enabled measurements is available": this message appears when in the Measurement mode the operator select certain parameters but the sensor is not mounted on the probe; turn off the meter, install the required sensors and procede with the measurements.



- "Please disconnect probe from meter before installing or removing any sensor!": this message appears when the operator removes a sensor without disconnect the probe and turn off the meter. To avoid sensors damages, please turn off the meter before any operation on the probe.



- "Error - Valid sensors config. is Temp, pH, ORP, Cond., DO, Pressure": in a lot, all the logged samples must have the same readings; this message appears trying to change the readings configuration in a lot with previous logged data; press OK and change logging lot to save the data.



- "Error - Current date and time precede the last logged sample!": this message appears when in the System Setup menu the operator has set time and date that are not compatible with the last logged data for the selected lot; press OK, set a correct value for time and date or save the desired value in another lot.



- "I2C bus error!": this message appears when an hardware problem on the meter occurs; turn off and turn on the meter; if the problem persists contact the nearest Hanna Center.



APPENDIX A - PROBE MAINTENANCE

HI 9828 is supplied complete with a maintenance probe kit. This kit includes HI 7042S (electrolyte solution for D.O. sensor), 5 O-rings for D.O. sensor, a small brush, 5 O-rings for multiparameter probe and a syringe with grease to lubricate the O-rings.

General maintenance

After using, rinse the probe with tap water and dry it; maintain wet the pH electrode bulb and dry the D.O. and EC sensors.

Maintenance of D.O. probe

For a top performance probe, it is recommended to replace the membrane every 2 months and the electrolyte once a month.

Proceed as follows:

- Unscrew the membrane by turning it counterclockwise.
- Rinse the supplied spare membrane with some electrolyte solution while shaking it gently. Refill with clean electrolyte.
- Gently tap the membrane over a surface to ensure that no air bubbles remain trapped.
- With the sensor facing down screw the cap clockwise to the end of the threads. Some electrolyte will overflow.

If any deposit scales the sensors, gently brush the sensor surface with the supplied brush, while paying attention to not damage the plastic body.

Maintenance of pH probe

- Remove the protective cap. DO NOT BE ALARMED IF ANY SALT DEPOSITS ARE PRESENT. This is normal with electrodes and they will disappear when rinsed with water.
- Shake the electrode down as you would do with a clinical thermometer to eliminate any air bubbles inside the glass bulb.
- If the bulb and/or junction are dry, soak the electrode in HI70300 Storage Solution for at least one hour.
- To minimize clogging and ensure a quick response time, the glass bulb and the junction should be kept moist and not allowed to dry.

- Replace solution in the protective cap with a few drops of HI70300 Storage Solution. Tap water may also be used for a very short period (couple of days).

NEVER STORE THE ELECTRODE IN DISTILLED WATER.

- Inspect the electrode for any scratches or cracks. If any present, replace the electrode.
- Cleaning Procedure: clean frequently the probe with HI 70670 or HI 70671 cleaning solutions by soaking it for 1 minute. After performing this procedure, soak the electrode in HI 70300 Storage solution before taking measurements.

Maintenance of EC probe

After every series of measurements, rinse the probe with tap water.

If a more thorough cleaning is required, clean the probe with the supplied brush or a nonabrasive detergent.

After cleaning the probe, always re-calibrate the instrument.

APPENDIX B - ACCESSORIES

HI 9828 ACCESSORIES

HI 769828PH	pH sensor, single junction, non refillable
HI 769828PHO	pH/ORP sensor
HI 769828DO	DO/Temperature sensor
HI 769828EC	EC sensor
HI 9828-25	Quick calibration solution, 500 mL solution
HI 9828-27	Quick calibration solution, 1 G solution
HI 7698281	USB interface cable
HI 92000	Software application
HI 920005	i-Button® with holder (5 pcs)
HI 7698282	Maintenance probe kit
HI 7698283	Calibration beaker
HI 7698284	Flow cell
HI 710045	Power supply cable
HI 710046	Ligther cigarette cable
HI 710005	115 Vac to 12 Vdc, US plug adapter
HI 710006	230 Vac to 12 Vdc, European plug adapter
HI 710012	230 Vac to 12 Vdc, UK plug adapter
HI 710013	230 Vac to 12 Vdc, South African plug adapter
HI 710014	230 Vac to 12 Vdc, Australian plug adapter

pH BUFFER SOLUTIONS

HI 5004	pH 4.01 buffer solution, 500 mL bottle
HI 5046	pH 4.63 buffer solution, 500 mL bottle
HI 5005	pH 5.00 buffer solution, 500 mL bottle
HI 5006	pH 6.00 buffer solution, 500 mL bottle
HI 5068	pH 6.86 buffer solution, 500 mL bottle
HI 5007	pH 7.01 buffer solution, 500 mL bottle
HI 5074	pH 7.41 buffer solution, 500 mL bottle
HI 5008	pH 8.00 buffer solution, 500 mL bottle
HI 5009	pH 9.00 buffer solution, 500 mL bottle
HI 5091	pH 9.18 buffer solution, 500 mL bottle

HI 5010 pH 10.01 buffer solution, 500 mL bottle

ORP TEST & PRETREATMENT SOLUTIONS

HI 7020L ORP test solution at 200/275 mV @ 20 °C, 500 mL bottle

HI 7021L ORP test solution at 240 mV @ 20 °C, 500 mL bottle

HI 7022L ORP test solution at 470 mV @ 20 °C, 500 mL bottle

HI 7091L Reducing pretreatment solution, 500 mL bottle

HI 7092L Oxidizing Pretreatment solution, 500 mL bottle

DISSOLVED OXYGEN SOLUTIONS

HI 7040L Zero oxygen solution, 500 mL bottle

HI 7042S Electrolyte solution, 30 mL bottle

CONDUCTIVITY BUFFER SOLUTIONS

HI 7030L 12880 $\mu\text{S}/\text{cm}$ standard solution, 500 mL bottle

HI 7031L 1413 $\mu\text{S}/\text{cm}$ standard solution, 500 mL bottle

HI 7033L 84 $\mu\text{S}/\text{cm}$ standard solution, 500 mL bottle

HI 7034L 80000 $\mu\text{S}/\text{cm}$ standard solution, 500 mL bottle

HI 7035L 111800 $\mu\text{S}/\text{cm}$ standard solution, 500 mL bottle

HI 7039L 5000 $\mu\text{S}/\text{cm}$ standard solution, 500 mL bottle

PROBE CLEANING & MAINTENANCE SOLUTIONS

HI 70670L Cleaning solution for salt deposits, 500 mL bottle

HI 70671L Cleaning and disinfection solution for algae, fungi and bacteria, 500 mL bottle

HI 70300 Electrode storage solution, 500 mL

APPENDIX C - WARRANTY

All Hanna Instruments meters are guaranteed for two years (sensors, electrodes and probes for six months) against defects in workmanship and materials when used for their intended purpose and maintained according to instructions.

This warranty is limited to repair or replacement free of charge. Damage due to accident, misuse, tampering or lack of prescribed maintenance are not covered.

If service is required, contact the dealer from whom you purchased the instrument. If under warranty, report the model number, date of purchase, serial number and the nature of the failure.

If the repair is not covered by the warranty, you will be notified of the charges incurred.

If the instrument is to be returned to Hanna Instruments, first obtain a Returned Goods Authorization number from the Customer Service department and then send it with shipping costs prepaid.

When shipping any instrument, make sure it is properly packaged for complete protection.

Recommendations for Users

Before using this product, make sure that it is entirely suitable for the environment in which it is used. Operation of this instrument in residential areas could cause unacceptable interferences to radio and TV equipment, requiring the operator to take all necessary steps to correct interferences. The glass bulb at the end of the electrode is sensitive to electrostatic discharges. Avoid touching this glass bulb at all time. To maintain the EMC performance of equipment, the recommended cables noted in the user's manual must be used. Any variation introduced by the user to the supplied equipment may degrade the instruments' EMC performance. To avoid electrical shock, do not use these instruments when voltage at the measurement surface exceed 24 Vac or 60 Vdc. To avoid damage or burns, do not perform any measurement in microwave ovens.

SALES AND TECHNICAL SERVICE CONTACTS

Australia:

Tel. (03) 9769.0666 • Fax (03) 9769.0699

China:

Tel. (10) 88570068 • Fax (10) 88570060

Egypt:

Tel. & Fax (02) 2758.683

Germany:

Tel. (07851) 9129-0 • Fax (07851) 9129-99

Greece:

Tel. (210) 823.5192 • Fax (210) 884.0210

Indonesia:

Tel. (21) 4584.2941 • Fax (21) 4584.2942

Japan:

Tel. (03) 3258.9565 • Fax (03) 3258.9567

Korea:

Tel. (02) 2278.5147 • Fax (02) 2264.1729

Malaysia:

Tel. (603) 5638.9940 • Fax (603) 5638.9829

Singapore:

Tel. 6296.7118 • Fax 6291.6906

South Africa:

Tel. (011) 615.6076 • Fax (011) 615.8582

Taiwan:

Tel. 886.2.2739.3014 • Fax 886.2.2739.2983

Thailand:

Tel. 66-2619-0708 • Fax 66-2619-0061

United Kingdom:

Tel. (01525) 850.855 • Fax (01525) 853.668

USA:

Tel. (401) 765.7500 • Fax (401) 765.7575

*For e-mail contacts and complete list of Sales and Technical offices, please see **www.hannainst.com***